

The fully integrated Surface Water Drainage Solution



Installing an effective, fully integrated surface water drainage system is

Easy As 1, 2, 3
Prepare • Install • Finish

EasyDRAIN™ Channel and Grate comes in 1 metre and 3 metre lengths and is made from tough, recycled UV stabilised polymer, making it super light and easy to handle.

The EasyDRAIN™ system allows for a range of configurations using the corners, tee pieces and slim pits that simply click together. Pre-moulded outlets allow for easy integration into your existing stormwater system.

EasyDRAIN™ Channel and components come complete with a choice of grates including pressed stainless steel and pressed galvanised steel, or black polymer that has a wheel load rating of 1.5 tonne, making it suitable for domestic driveways.

Best of all, installation requires just three easy steps – prepare, install, finish.

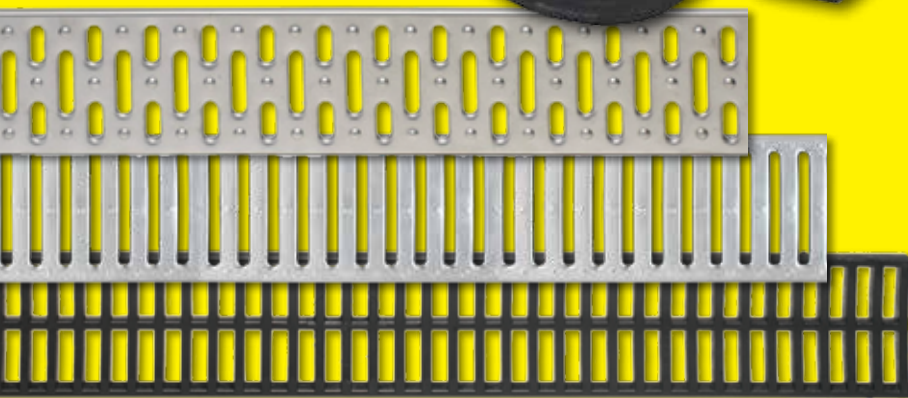

*Flat upper surface of metal grates may show signs of slight indentation over time if used in a driveway.

*Galvanised grates are not suitable around swimming pools or environments affected by salt water.

SURFACE WATER DRAINAGE



EasyDRAIN™ CHANNEL & GRATE

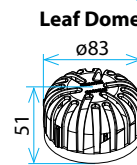
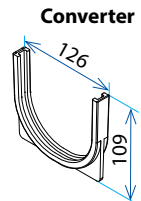
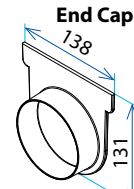
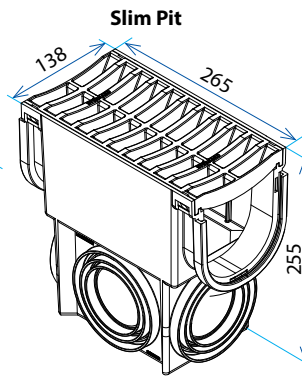
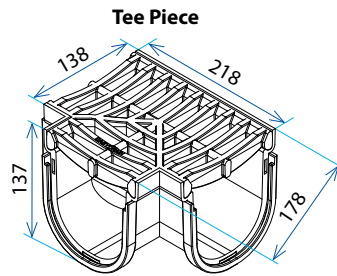
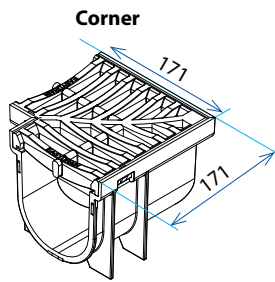
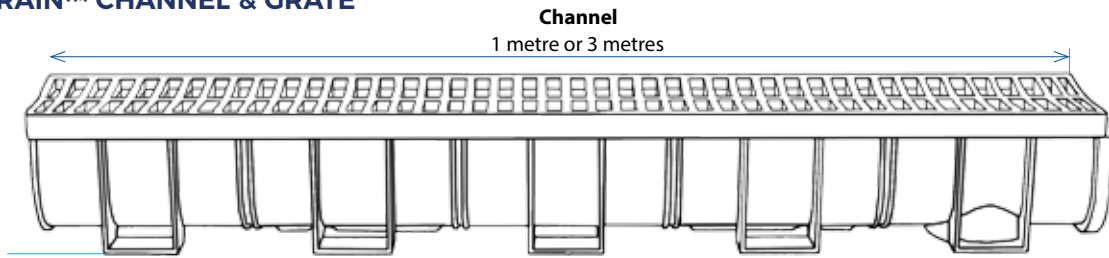

Note: Dimensions are nominal due to the nature of polymer.

- Made from tough, recycled, UV stabilised polymer, the channel is super-light and easy to handle.
- Channel lengths easily join together and with other components by simply clicking together.
- 200mm paver-length segments which are moulded into the channel allow for easy cutting and rejoining using the converters.
- Connection to storm water pipes can be made to the moulded-in 90mm bottom outlet.
- The channel with polymer grates, once correctly installed in concrete, is

rated to 1.5 tonne wheel loads.

- Polymer grates and galvanised round bar grates are rated Class A.
- Various colours and a range of grates to choose from.
- 100% Australian made.

EasyDRAIN™ BLACK POLYMER CHANNEL & BLACK POLYMER GRATE

EasyDRAIN™ Black Polymer Channel with Black Polymer Grate - 1 metre		EasyDRAIN™ Black Polymer Channel with Black Polymer Grate - 3 metres prejoined		EasyDRAIN™ Black Polymer Channel with Black Polymer Grate - 1 metre x 3 Pack + End Cap	
PRODUCT CODE		PRODUCT CODE		PRODUCT CODE	
83300	9 314319 023539	83390	9 314319 027148	83387	9 314319 036775
WEIGHT (Kg)	2.70	WEIGHT (Kg)	8.10	WEIGHT (Kg)	8.25
EasyDRAIN™ Black Polymer Corner with Black Polymer Grate		EasyDRAIN™ Black Polymer Tee Piece with Black Polymer Grate		EasyDRAIN™ Black Polymer Slim Pit with Black Polymer Grate	
PRODUCT CODE		PRODUCT CODE		PRODUCT CODE	
83330	9 314319 023645	83400	9 314319 030209	83800	9 314319 034795
WEIGHT (Kg)	0.54	WEIGHT (Kg)	0.66	WEIGHT (Kg)	1.11

SURFACE WATER DRAINAGE



EasyDRAIN™ PARTS

EasyDRAIN™ Black Polymer End Cap	EasyDRAIN™ Black Polymer Converter	EasyDRAIN™ Black Polymer Leaf Dome
PRODUCT CODE 83360	PRODUCT CODE 83370	PRODUCT CODE 84040
WEIGHT (Kg) 0.06	WEIGHT (Kg) 0.03	WEIGHT (Kg) 0.02

EasyDRAIN™ CHANNEL BLACK POLYMER & PRESSED GALVANISED STEEL GRATE

EasyDRAIN™ Black Polymer Channel with Pressed Galvanised Steel Grate - 1 metre	EasyDRAIN™ Black Polymer Channel with Pressed Galvanised Steel Grate - 3 metres prejoined	
PRODUCT CODE 83432	PRODUCT CODE 83433	
WEIGHT (Kg) 3.10	WEIGHT (Kg) 9.30	

EasyDRAIN™ Black Polymer Corner with Pressed Galvanised Steel Grate	EasyDRAIN™ Black Polymer Tee Piece with Pressed Galvanised Steel Grate	EasyDRAIN™ Black Polymer Slim Pit with Pressed Galvanised Steel Grate
PRODUCT CODE 83338	PRODUCT CODE 83900	PRODUCT CODE 83802
WEIGHT (Kg) 0.60	WEIGHT (Kg) 0.66	WEIGHT (Kg) 1.21



EasyDRAIN™ Slim Pit

- Allows seamless connection to the stormwater system.
- Moulded outlets for joining to 75mm, 90mm and 100mm PVC pipe.
- Grates available in Black Polymer, Punched Stainless Steel and Galvanised Steel.



EasyDRAIN™ Corner and EasyDRAIN™ Tee Piece

- Allows for an easy change of direction.
- Simple click together joining mechanism with the EasyDRAIN™ channel.
- Various colours and a range of grates to choose from.



EasyDRAIN™ End Cap

- Provides a finishing point where the stormwater pipe is connected to the base of the channel.
- Acts as a connector to 90mm PVC stormwater pipe using the easy cut-out feature.



EasyDRAIN™ Converter

- Acts as a joiner between cut ends of EasyDRAIN™ channel.
- Connects together male ends of channel to a Corner, Tee Piece or End Cap.







Leaf Dome

- Placed at the connection between the channel and stormwater pipe.
- Provides a barrier against leaves and other debris from entering the waterways.

SURFACE WATER DRAINAGE



EasyDRAIN™ BLACK POLYMER CHANNEL & PRESSED STAINLESS STEEL GRATE

				
EasyDRAIN™ Black Polymer Channel with Pressed Stainless Steel Grate - 1 metre		EasyDRAIN™ Black Polymer Channel with Pressed Stainless Steel Grate - 3 metres prejoined		
PRODUCT CODE		PRODUCT CODE		
83303		83393		
WEIGHT (Kg)		WEIGHT (Kg)		
3.10		9.30		

					
EasyDRAIN™ Black Polymer Corner with Pressed Stainless Steel Grate		EasyDRAIN™ Black Polymer Tee Piece with Pressed Stainless Steel Grate		EasyDRAIN™ Black Polymer Slim Pit with Pressed Stainless Steel Grate	
PRODUCT CODE		PRODUCT CODE		PRODUCT CODE	
83333		83901		83801	
WEIGHT (Kg)		WEIGHT (Kg)		WEIGHT (Kg)	
0.60		0.66		1.21	

EasyDRAIN™ BLACK POLYMER CHANNEL & GALVANISED STEEL ROUND BAR GRATE

The EasyDRAIN™ Round Bar Hot-dipped Galvanised Grate provides a robust grate suitable for domestic driveways and pathways. It is bike and wheelchair safe and heel friendly.



			
EasyDRAIN™ Black Polymer Channel with Galvanised Round Bar Grate - 1 metre		EasyDRAIN™ Black Polymer Channel with Galvanised Round Bar Grate - 3 metres prejoined	
PRODUCT CODE		PRODUCT CODE	
83307		83395	
WEIGHT (Kg)		WEIGHT (Kg)	
5.64		16.92	

SURFACE WATER DRAINAGE



EasyDRAIN™ BLACK POLYMER CHANNEL ONLY



EasyDRAIN™ Channel in black polymer lets you choose which grate best suits the situation.



EasyDRAIN™ Black Polymer Channel Only - 1 metre

PRODUCT CODE	 9 314319 023584
83310	
WEIGHT (Kg)	
1.60	



EasyDRAIN™ Black Polymer Channel Only - 3 metres pre-joined

PRODUCT CODE	 9 314319 027247
83313	
WEIGHT (Kg)	
4.80	



EasyDRAIN™ Black Polymer Corner Channel Only

PRODUCT CODE	 9 314319 023683
83340	
WEIGHT (Kg)	
0.30	



EasyDRAIN™ Black Polymer Tee Piece Channel Only

PRODUCT CODE	 9 314319 030216
83410	
WEIGHT (Kg)	
0.34	



EasyDRAIN™ Black Polymer Slim Pit Case Only

PRODUCT CODE	 9 314319 034825
83810	
WEIGHT (Kg)	
0.84	

EasyDRAIN™ STANDARD BLACK POLYMER GRATES ONLY



EasyDRAIN™ Black Polymer Grate Only - 1 metre

PRODUCT CODE	 9 314319 023614
83320	
WEIGHT (Kg)	
1.10	



EasyDRAIN™ Black Polymer Corner Grate Only

PRODUCT CODE	 9 314319 023638
83350	
WEIGHT (Kg)	
0.25	



EasyDRAIN™ Black Polymer Tee Piece Grate Only

PRODUCT CODE	 9 314319 030223
83420	
WEIGHT (Kg)	
0.32	

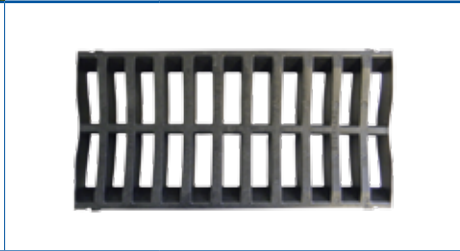

EasyDRAIN™ Black Polymer Slim Pit Grate Only

PRODUCT CODE	 9 314319 035655
83820	
WEIGHT (Kg)	
0.27	

SURFACE WATER DRAINAGE



EasyDRAIN™ HEEL FRIENDLY BLACK POLYMER GRATES ONLY

EasyDRAIN™ Black Heel Friendly Polymer Grate - 1 metre		EasyDRAIN™ Black Heel Friendly Polymer Corner Grate	
PRODUCT CODE		PRODUCT CODE	
83520		83620	
WEIGHT (Kg)		WEIGHT (Kg)	
0.75	9 314319 034726	0.13	9 314319 034764



EasyDRAIN™ PRESSED GALVANISED STEEL GRATES ONLY



EasyDRAIN™ Pressed Galvanised Steel range of grates provide a heel friendly pattern suitable for pedestrian areas and pathways. Not suitable around swimming pools or areas subject to salt water environments such as coastal areas.



EasyDRAIN™ Pressed Galvanised Steel Grate Only - 1 metre	
PRODUCT CODE	
96059	
WEIGHT (Kg)	
1.50	9 314319 034887



EasyDRAIN™ Pressed Galvanised Steel Corner Grate Only		EasyDRAIN™ Pressed Galvanised Steel Tee Piece Grate Only		EasyDRAIN™ Pressed Galvanised Steel Slim Pit Grate Only	
PRODUCT CODE		PRODUCT CODE		PRODUCT CODE	
96060		96061		96063	
WEIGHT (Kg)		WEIGHT (Kg)		WEIGHT (Kg)	
0.30	9 314319 034894	0.32	9 314319 034900	0.37	9 314319 034924



SURFACE WATER DRAINAGE



EasyDRAIN™ PRESSED STAINLESS STEEL GRATES ONLY



EasyDRAIN™ Pressed Stainless Steel Grate Only - 1 metre

PRODUCT CODE

97823

WEIGHT (Kg)

1.50



9 314319 023522



EasyDRAIN™ Pressed Stainless Steel Corner Grate Only

PRODUCT CODE

97824

WEIGHT (Kg)

0.30



9 314319 023744



EasyDRAIN™ Pressed Stainless Steel Tee Piece Grate Only

PRODUCT CODE

96064

WEIGHT (Kg)

0.32



9 314319 034931



EasyDRAIN™ Pressed Stainless Steel Slim Pit Grate Only

PRODUCT CODE

96062

WEIGHT (Kg)

0.37



9 314319 034917

EasyDRAIN™ GALVANISED ROUND BAR GRATE ONLY

The EasyDRAIN™ Round Bar Hot-dipped Galvanised Grate provides a robust grate suitable for domestic driveways and pathways. It is bike and wheelchair safe and heel friendly.

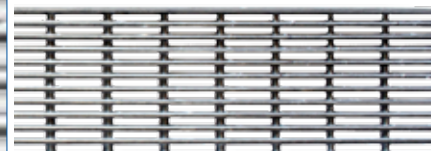

EasyDRAIN™ Galvanised Steel Round Bar Grate Only - 1 metre

PRODUCT CODE

21099

WEIGHT (Kg)

4.04



9 314319 029494

EasyDRAIN™ Channel & Grate Installation Instructions

1 Prepare Trench

- Dig a trench 185mm deep and 250mm 250mm wide.
- Place compacted bedding sand or concrete in the base of the trench.
- Use a string line to ensure straightness and the correct finish height.
- Attach the grates to the channel prior to installation.

2 Install Channel

- Connect End Cap to the ends of EasyDRAIN™ channel and seal with silicone.
- If required, cut the EasyDRAIN™ channel to the desired length.
- Cut an outlet in the base of the channel or End Cap as required to connect to PVC pipe.
- Connect lengths of channel as necessary ensuring that the joints click together.

3 Finish Installation

- Place a suitable expansion material material along the top edge of the channel.
- Pour concrete around each side of the EasyDRAIN™ channel ensuring that the the base of the channel is completely immersed.
- Finish the concrete to approximately 3mm above the level of the grate.

SURFACE WATER DRAINAGE



EasyDRAIN™ Channel and Grate

EURODESIGN 316 STAINLESS STEEL GRATES ONLY

	EasyDRAIN™ EURODESIGN 316 Stainless Steel Heel Friendly Grate Only - 1 metre	EasyDRAIN™ EURODESIGN 316 Stainless Steel Heel Friendly Grate Only - 600mm												
<table border="1"> <tr><td>PRODUCT CODE</td><td rowspan="3"> </td> </tr> <tr><td>97841</td></tr> <tr><td>WEIGHT (Kg)</td></tr> </table>	PRODUCT CODE		97841	WEIGHT (Kg)	<table border="1"> <tr><td>PRODUCT CODE</td><td rowspan="3"> </td> </tr> <tr><td>97842</td></tr> <tr><td>WEIGHT (Kg)</td></tr> </table>	PRODUCT CODE		97842	WEIGHT (Kg)					
PRODUCT CODE														
97841														
WEIGHT (Kg)														
PRODUCT CODE														
97842														
WEIGHT (Kg)														
3.58	1.90													
EasyDRAIN™ EURODESIGN 316 Stainless Steel Heel Friendly Corner Grate Only	EasyDRAIN™ EURODESIGN 316 Stainless Steel Heel Friendly Tee Piece Grate Only	EasyDRAIN™ EURODESIGN 316 Stainless Steel Heel Friendly Slim Pit Grate Only												
<table border="1"> <tr><td>PRODUCT CODE</td><td rowspan="3"> </td> </tr> <tr><td>97843</td></tr> <tr><td>WEIGHT (Kg)</td></tr> </table>	PRODUCT CODE		97843	WEIGHT (Kg)	<table border="1"> <tr><td>PRODUCT CODE</td><td rowspan="3"> </td> </tr> <tr><td>97850</td></tr> <tr><td>WEIGHT (Kg)</td></tr> </table>	PRODUCT CODE		97850	WEIGHT (Kg)	<table border="1"> <tr><td>PRODUCT CODE</td><td rowspan="3"> </td> </tr> <tr><td>97835</td></tr> <tr><td>WEIGHT (Kg)</td></tr> </table>	PRODUCT CODE		97835	WEIGHT (Kg)
PRODUCT CODE														
97843														
WEIGHT (Kg)														
PRODUCT CODE														
97850														
WEIGHT (Kg)														
PRODUCT CODE														
97835														
WEIGHT (Kg)														
0.72	1.06	0.90												

EasyDRAIN™ TERRACOTTA POLYMER GRATES ONLY

EasyDRAIN™ Terracotta Polymer Grate Only - 1 metre	EasyDRAIN™ Terracotta Polymer Corner Grate Only	EasyDRAIN™ Terracotta Polymer Tee Piece Grate Only												
<table border="1"> <tr><td>PRODUCT CODE</td><td rowspan="3"> </td> </tr> <tr><td>83321</td></tr> <tr><td>WEIGHT (Kg)</td></tr> </table>	PRODUCT CODE		83321	WEIGHT (Kg)	<table border="1"> <tr><td>PRODUCT CODE</td><td rowspan="3"> </td> </tr> <tr><td>83351</td></tr> <tr><td>WEIGHT (Kg)</td></tr> </table>	PRODUCT CODE		83351	WEIGHT (Kg)	<table border="1"> <tr><td>PRODUCT CODE</td><td rowspan="3"> </td> </tr> <tr><td>83421</td></tr> <tr><td>WEIGHT (Kg)</td></tr> </table>	PRODUCT CODE		83421	WEIGHT (Kg)
PRODUCT CODE														
83321														
WEIGHT (Kg)														
PRODUCT CODE														
83351														
WEIGHT (Kg)														
PRODUCT CODE														
83421														
WEIGHT (Kg)														
1.10	0.25	0.32												

EasyDRAIN™ SANDSTONE POLYMER GRATES ONLY

EasyDRAIN™ Sandstone Polymer Grate Only - 1 metre	EasyDRAIN™ Sandstone Polymer Corner Grate Only	EasyDRAIN™ Sandstone Polymer Tee Piece Grate Only												
<table border="1"> <tr><td>PRODUCT CODE</td><td rowspan="3"> </td> </tr> <tr><td>83322</td></tr> <tr><td>WEIGHT (Kg)</td></tr> </table>	PRODUCT CODE		83322	WEIGHT (Kg)	<table border="1"> <tr><td>PRODUCT CODE</td><td rowspan="3"> </td> </tr> <tr><td>83352</td></tr> <tr><td>WEIGHT (Kg)</td></tr> </table>	PRODUCT CODE		83352	WEIGHT (Kg)	<table border="1"> <tr><td>PRODUCT CODE</td><td rowspan="3"> </td> </tr> <tr><td>83422</td></tr> <tr><td>WEIGHT (Kg)</td></tr> </table>	PRODUCT CODE		83422	WEIGHT (Kg)
PRODUCT CODE														
83322														
WEIGHT (Kg)														
PRODUCT CODE														
83352														
WEIGHT (Kg)														
PRODUCT CODE														
83422														
WEIGHT (Kg)														
1.10	0.25	0.32												